

2106 & 2110 Instructions - Section 11

2106 Receiver, Part # 310 104 318 • Mounting Specifications

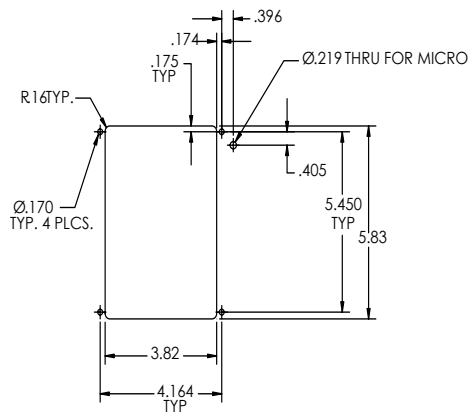
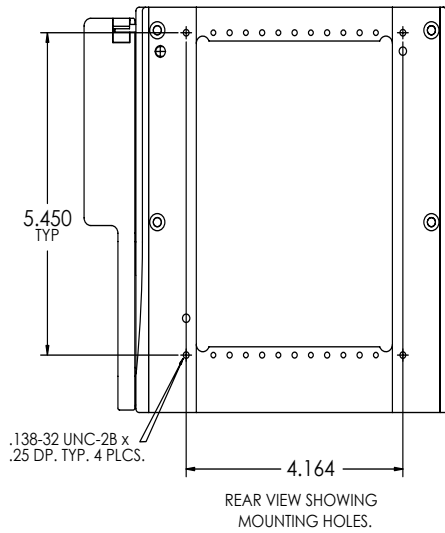
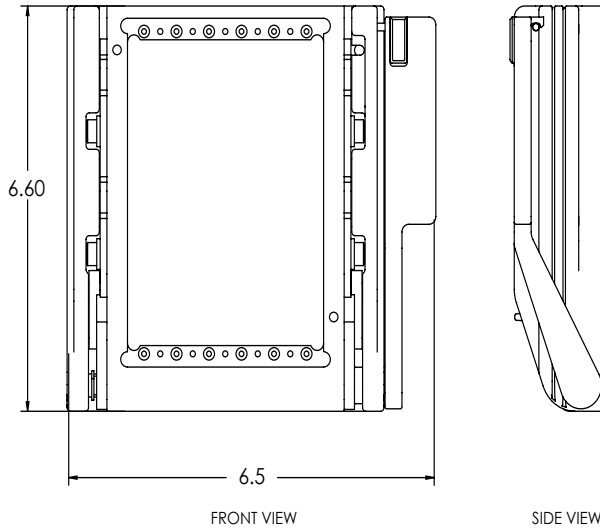

MOUNTING HOLE SPECIFICATIONS